

# SENCO®

## PC1130 Electric Air Compressor

Senco Products Inc.  
8485 Broadwell Road  
Cincinnati, Ohio 45244

Operating Instructions

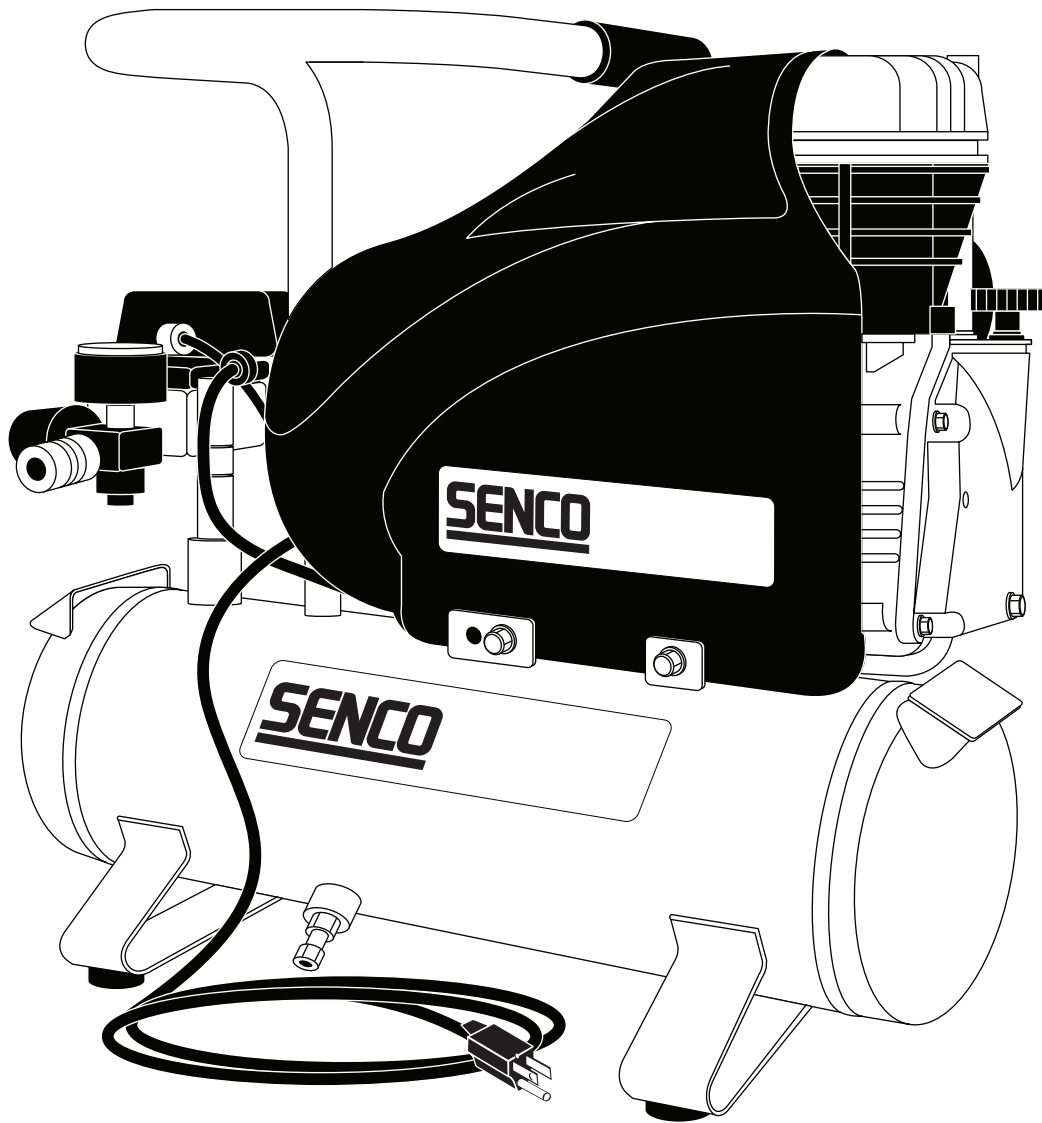

Warnings for the safe use of this tool are included in this manual.

Questions? Comments?  
call SENCO'S toll-free Action-line: 1-800-543-4596  
or e-mail: [toolprof@senco.com](mailto:toolprof@senco.com) Visit our Website [www.senco.com](http://www.senco.com)



© 2006 by Senco Products, Inc.

PC1130 Electric Compressor  
Issued Oct. 18, 2006

# TABLE OF CONTENTS

<b>INTRODUCTION</b> .....	<b>3</b>
SAFETY ALERT .....	3
INSPECTION .....	3
<b>SAFETY WARNINGS</b> .....	<b>4</b>
ELECTRICAL .....	4
EXPLOSION OR FIRE .....	5
BURSTING .....	5
BREATHING .....	6
BURNS .....	6
FLYING OBJECTS .....	6
MOVING PARTS .....	7
NEGLIGENCE .....	7
AIR COMPRESSOR DAMAGE .....	7
<b>COMPRESSOR FEATURES</b> .....	<b>8</b>
<b>PREPARATION</b> .....	<b>10</b>
INITIAL SET-UP .....	10
LOCATION .....	10
ELECTRICAL .....	10
<b>OPERATION</b> .....	<b>11</b>
PRE-START CHECKLIST .....	11
START-UP .....	11
SHUTDOWN .....	11
<b>MAINTENANCE</b> .....	<b>11</b>
<b>TROUBLESHOOTING</b> .....	<b>12-14</b>
<b>SPECIFICATIONS</b> .....	<b>15</b>
<b>WARRANTY</b> .....	<b>16</b>

## INTRODUCTION

Congratulations on the purchase of your new SENCO® Air Compressor! You can be assured your SENCO Air Compressor was constructed with the highest level of precision and accuracy. Each component has been rigorously tested by technicians to ensure the quality, endurance and performance of this air compressor.

This operator's manual was compiled for your benefit. By reading and following the simple safety, installation and operation, maintenance and troubleshooting steps described in this manual, you will receive years of troublefree operation from your new SENCO® Air Compressor. The contents of this manual are based on the latest product information available at the time of publication. The manufacturer reserves the right to make changes in price, color, materials equipment, specifications or models at any time without notice.



### SAFETY ALERT!

A "**DANGER, WARNING or CAUTION**" safety warning will be surrounded by a "SAFETY ALERT BOX". This box is used to designate and emphasize Safety Warnings that must be followed when operating this air compressor. Accompanying the safety warnings are "Signal Words" which designate the degree or level of hazard seriousness. The "Signal Words" used in this manual are as follows:

**DANGER:** Indicates an imminently hazardous situation which, if not avoided, **WILL** result in death or serious injury.

**WARNING:** Indicates a potentially hazardous situation which, if not avoided, **COULD** result in death or serious injury.

**CAUTION:** Indicates a potentially hazardous situation which, if not avoided **MAY** result in minor or moderate injury or damage to the air compressor.



The symbols set to the left of this paragraph are "Safety Alert Symbols". These symbols are used to call attention to items or procedures that could be dangerous to you or other persons using this equipment.

**ALWAYS PROVIDE A COPY OF THIS MANUAL TO ANYONE USING THIS EQUIPMENT. READ ALL INSTRUCTIONS IN THIS MANUAL AND ANY INSTRUCTIONS SUPPLIED BY MANUFACTURERS OF SUPPORTING EQUIPMENT BEFORE OPERATING THIS AIR COMPRESSOR AND ESPECIALLY POINT OUT THE "SAFETY WARNINGS" TO PREVENT THE POSSIBILITY OF PERSONAL INJURY TO THE OPERATOR.**

## INSPECTION

Unbox the air compressor and write in the serial number in the space provided below. Inspect for signs of obvious or concealed freight damage. Be sure that all damaged parts are replaced and any mechanical problems are corrected prior to the operation of the air compressor.

**SERIAL NUMBER** \_\_\_\_\_

If you have Questions or Comments call SENCO's toll-free Action-line: **1-800-543-4596** or, e-mail: [toolprof@Senco.com](mailto:toolprof@Senco.com)

Please have the following information available for all service calls:

1. Model Number
2. Serial Number
3. Date and Place of Purchase

Senco® Corporation 8485 Broadwell Road, Cincinnati, OH 45244



# SAFETY WARNINGS

READ ALL SAFETY WARNINGS BEFORE USING AIR COMPRESSOR

## HAZARD

## POTENTIAL CONSEQUENCE

## PREVENTION

**RISK OF  
ELECTRIC SHOCK  
OR  
ELECTROCUTION**



Serious injury or death could occur if the air compressor is not properly grounded. Your air compressor is powered by electricity and may cause electric shock or electrocution if not used properly.

Electrical shock may occur from electrical cord.

Electrical shock may occur if air compressor is not operated properly.

Serious injury or death may occur if electrical repairs are attempted by unqualified persons.

Make sure the air compressor is plugged into a properly grounded outlet which provides correct voltage and adequate fuse protection.

Check power cord for signs of crushing, cutting or heat damage. Replace faulty cord before use.

Keep all connections dry and off the ground. Do not allow electrical cords to lay in water or in such a position where water could come in contact with them. Do not touch plug with wet hands.

Do not pull on the electrical cord to disconnect from the outlet.

Never operate air compressor in wet conditions or outdoors when it is raining.

Never operate air compressor with safety guards/covers removed or damaged.

Any electrical wiring or repairs performed on this air compressor should be done by Authorized Service Personnel in accordance with National and Local electrical codes.

Before opening any electrical enclosure, always shut off the air compressor, relieve pressure and unplug the air compressor from the power source. Allow air compressor to cool down. Never assume the air compressor is safe to work on just because it is not operating. It could restart at any time!



# SAFETY WARNINGS



READ ALL SAFETY WARNINGS BEFORE USING AIR COMPRESSOR

HAZARD	POTENTIAL CONSEQUENCE	PREVENTION
<p data-bbox="64 163 341 220"><b>RISK OF EXPLOSION OR FIRE</b></p> <div data-bbox="53 239 352 541"></div> <div data-bbox="53 560 352 863"></div>	<p data-bbox="414 163 852 262">Serious injury or death may occur from normal electrical sparks in motor and pressure switch.</p> <p data-bbox="414 560 852 682">Serious injury may occur if any air compressor ventilation openings are restricted, causing the air compressor to overheat and start on fire.</p>	<p data-bbox="876 163 1291 315">Always operate air compressor in a well ventilated area free of flammable vapors, combustible dust, gases or other combustible materials.</p> <p data-bbox="876 373 1291 525">If spraying flammable material, locate the air compressor at least 20 feet away from the spray area. (An additional hose may be required.)</p> <p data-bbox="876 560 1291 711">Never place objects against or on top of air compressor. Operate air compressor at least 12 inches away from any wall or obstruction that would restrict proper ventilation.</p>
<p data-bbox="121 934 267 991"><b>RISK OF BURSTING</b></p> <div data-bbox="53 1020 352 1323"></div>	<p data-bbox="414 924 852 1022">Serious injury or death may occur from an air tank explosion if air tanks are not properly maintained.</p> <p data-bbox="414 1354 852 1505">Serious injury may occur from an air compressor malfunction or exploding accessories if incorrect system components, attachments or accessories are used.</p>	<p data-bbox="876 924 1291 1022">Drain air tank daily or after each use to prevent moisture buildup in the air tank.</p> <p data-bbox="876 1045 1291 1228">If air tank develops a leak, replace the air tank immediately. Never repair, weld or make modifications to the air tank or its attachments. Use only genuine SENCO® repair parts for your air compressor.</p> <p data-bbox="876 1255 1291 1318">Never make adjustments to the factory set pressures.</p> <p data-bbox="876 1354 1291 1438">Never exceed manufacturers maximum allowable pressure rating of attachments.</p> <p data-bbox="876 1470 1291 1564">Because of extreme heat, do not use plastic pipe or lead tin soldered joints for a discharge line.</p> <p data-bbox="876 1596 1291 1680">Never use air compressor to inflate small, low pressure objects such as toys.</p>

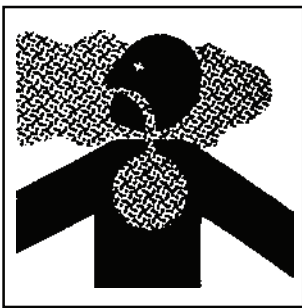
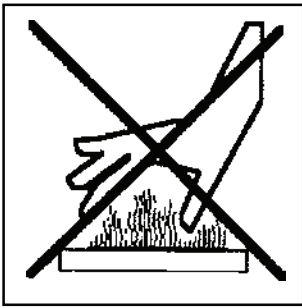

# SAFETY WARNINGS

READ ALL SAFETY WARNINGS BEFORE USING AIR COMPRESSOR

HAZARD	POTENTIAL CONSEQUENCE	PREVENTION
<p><b>RISK TO BREATHING</b></p> 	<p>Serious injury or death could occur from inhaling compressed air. The air stream may contain carbon monoxide, toxic vapors or solid particles.</p> <p>Sprayed materials such as paint, paint solvents, paint remover, insecticides, weed killers, etc. contain harmful vapors and poisons.</p>	<p>Never inhale air from the air compressor either directly or from a breathing device connected to the air compressor.</p> <p>Operate air compressor only in a well ventilated area. Follow all safety instructions provided with the materials you are spraying. Use of a respirator may be required when working with some materials.</p>
<p><b>RISK OF BURNS</b></p> 	<p>Serious injury could occur from touching exposed metal parts. These areas can remain hot for some time after the air compressor is shutdown.</p>	<p>Never allow any part of your body or other materials to make contact with any exposed metal parts on the air compressor.</p>
<p><b>RISK OF FLYING OBJECTS</b></p> 	<p>Soft tissue damage can occur from the compressed air stream.</p> <p>Serious injury can occur from loose debris being propelled at a high speed from the compressed air stream.</p>	<p>Always wear OSHA required "Z87" safety glasses to shield the eyes from flying debris.</p> <p>Never point the air stream at any part of your body, anyone else or animals.</p> <p>Never leave pressurized air compressor unattended. Shut off air compressor and relieve pressure before attempting maintenance, attaching tools or accessories.</p> <p>Always maintain a safe distance from people and animals while operating the air compressor.</p> <p>Do not move the air compressor while air tank is under pressure. Do not attempt to move the air compressor by pulling on the hose.</p>



# SAFETY WARNINGS

READ ALL SAFETY WARNINGS BEFORE USING AIR COMPRESSOR

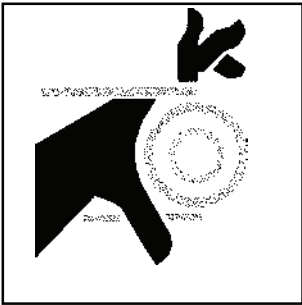
HAZARD	POTENTIAL CONSEQUENCE	PREVENTION
<p><b>RISK FROM MOVING PARTS</b></p> 	<p>Risk of bodily injury from moving parts. This air compressor cycles automatically when the pressure switch is in the "On/Auto" position.</p> <p>Risk of injury from negligent use.</p>	<p>Always turn off air compressor. Bleed pressure from the air hose and unplug from electrical outlet before performing maintenance. All repairs to the air compressor should be made by an Authorized Service person. Never assume the air compressor is safe to work on just because it is not operating. It could restart at any time!</p> <p>Do not operate without protective covers/guards. Replace damaged covers/guards before using the air compressor.</p>
<p><b>RISK FROM NEGLIGENCE</b></p>		<p>Never allow children or adolescents to operate this air compressor!</p> <p>Stay alert-watch what you are doing. Do not operate the air compressor when fatigued or under the influence of alcohol or drugs.</p> <p>Know how to stop the air compressor. Be thoroughly familiar with controls.</p>
<p><b>RISK OF AIR COMPRESSOR DAMAGE</b></p>	<p>Risk of major repair</p>	<p>Do not operate air compressor without an air filter.</p> <p>Do not operate air compressor in a corrosive environment.</p> <p>Do not incline the air compressor transversely or longitudinally more than 10 °.</p> <p>Always operate the air compressor in a stable, secure position to prevent air compressor from falling. Follow all maintenance instructions listed in this manual.</p>

**! SAVE THESE INSTRUCTIONS !**

**! WARNING**

This product contains one or more chemicals known to the State of California to cause cancer and birth defects or other reproductive harm.

# COMPRESSOR FEATURES

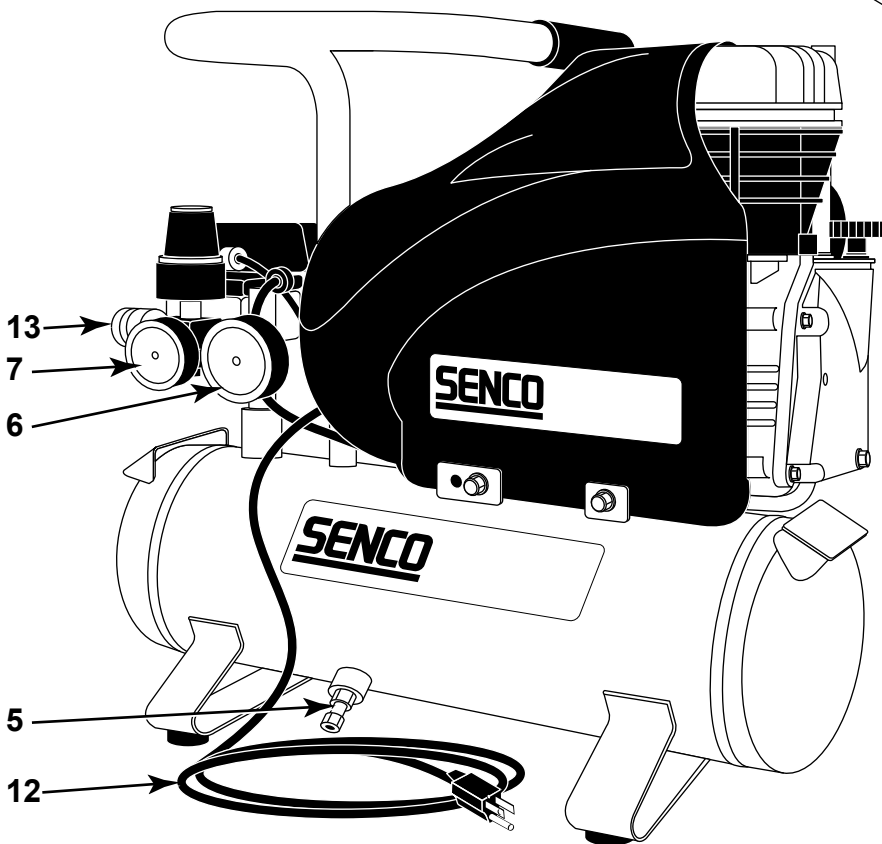
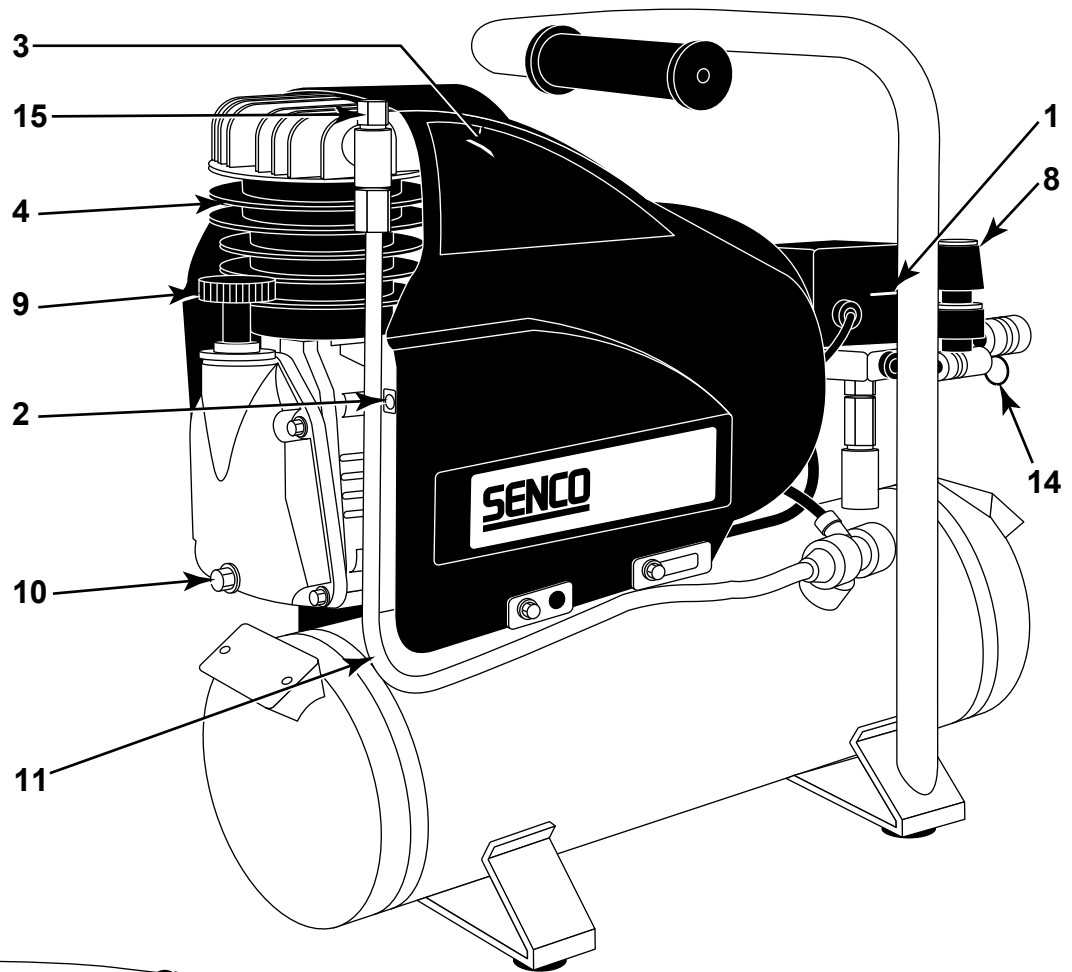

- 1 Motor/Pressure Switch
- 2 Motor Thermal Overload
- 3 Air Intake Filter
- 4 Air Compressor Pump
- 5 Air Tank Drain Valve
- 6 Air Tank Pressure Gauge
- 7 Outlet Pressure Gauge
- 8 Pressure Regulator
- 9 Dipstick
- 10 Oil Drain
- 11 Delivery tube
- 12 115 Volt electric power cord
- 13 Quick disconnect
- 14 Safety relief valve
- 15 Cold start valve



# COMPRESSOR FEATURES

**1) MOTOR/PRESSURE SWITCH:** This switch is used to start or stop the air compressor. Moving the switch to the "Auto" (On) position will provide automatic power to the pressure switch which will allow the motor to start when the air tank pressure is below the factory set "cut-in" pressure. When in the On Position, the pressure switch stops the motor when the air tank pressure reaches the factory set "cut-out" pressure. For safety purposes, this switch also has a pressure release valve located below the switch designed to automatically release compressed air from the air compressor pump head and its discharge line when the air compressor reaches "cut-out" pressure or is shut off. This allows the motor to restart freely. Moving the switch to the "Off" position will remove power from the motor and stop the air compressor.

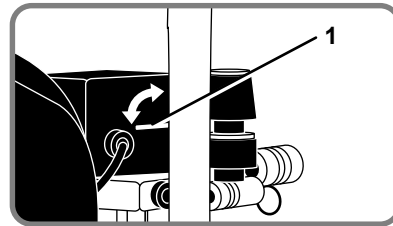

**2) MOTOR THERMAL OVERLOAD:** The electric motor has a manual resettable overload protector. If the motor draws excessive current for any reason, the thermal overload will cut off power, thus preventing the motor from being damaged. Wait until the motor is cool before pressing the reset button to begin working again. If multiple reset result in consistent trips, check service and/or reference extension cord sizing recommendations.



**3) AIR INTAKE FILTER:** This filter is designed to clean air coming into the pump. To ensure the pump continually receives a clean, cool, dry air supply this filter must always be clean and ventilation opening free from obstructions. The filter can be removed for cleaning by using warm, soapy water. Rinse the filter and air dry. Replace filter when necessary.

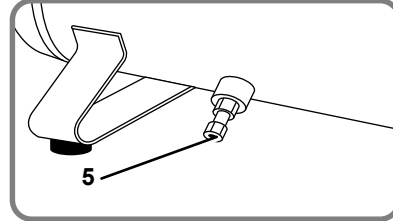

**4) AIR COMPRESSOR PUMP:** To compress air, the piston moves up and down in the cylinder. On the downstroke, air is drawn in through the air intake valve while the exhaust valve remains closed. On the upstroke, air is compressed, the intake valve closes and compressed air is forced out through the exhaust valve, into the discharge line, through the check valve and into the air tank.

**5) AIR TANK DRAIN VALVE:** The drain valve is used to remove moisture from the air tank(s) after the air compressor is shut off. **NEVER attempt to open the drain valve when more than 10 PSI of air pressure is in the air tank!** To open the drain valve, turn the knob counterclockwise.

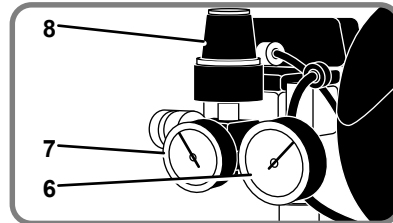

**6) AIR TANK PRESSURE GAUGE:** The air tank pressure gauge indicates the reserve air pressure in the air tank (s).

**7) OUTLET PRESSURE GAUGE:** The outlet pressure gauge indicates the air pressure available at the outlet side of the regulator. This pressure is controlled by the regulator and is always less or equal to the air tank pressure.

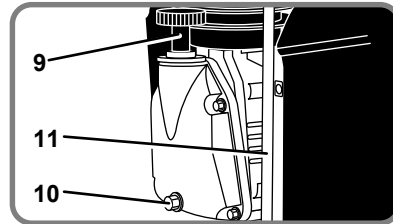

**8) PRESSURE REGULATOR:** The air pressure coming from the air tank is controlled by the regulator knob. Turn the pressure regulation knob clockwise to increase discharge pressure, and counterclockwise to decrease discharge pressure.

**9) OIL DIPSTICK:** The dipstick will register the amount of oil in the pump. Oil level should be checked on a daily basis to ensure that it does not exceed the maximum notch or fall below the minimum notch on the dipstick. Air escaping from the vent is normal.

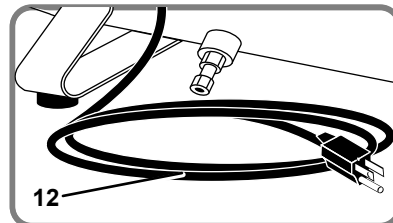

**10) OIL DRAIN:** The drain is provided to remove oil that has exceeded its service life. Drain oil into approved container and dispose of properly. Refill prior to starting.

**11) RISK OF BURNS** Head and discharge lines can be very hot. **Do not touch until unit has cooled after use.**

**12) POWER CORD:** Use only 115VAC 15A service. See extension cord recommendations on page 10.

**13) QUICK DISCONNECT:** Spring loaded sealed coupling for easy hose removal. 1/4".

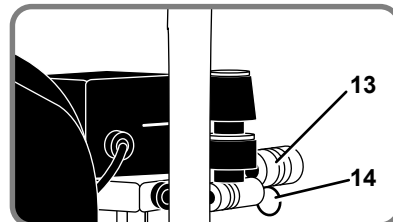

**14) SAFETY RELIEF VALVE:** This valve is designed to prevent system failures by relieving pressure from the system if compressed air reaches a predetermined level. The valve is preset by the manufacturer and must not be modified in any way. To verify the valve is working properly, pull on the ring. Air pressure should escape. When the ring is released, it will reset.

**15) COLD START VALVE:** The compressor is provided with a normally open valve. This valve will relieve compressed air for a few seconds at compressor start up allowing the motor to reach operating speed with low pump resistance.

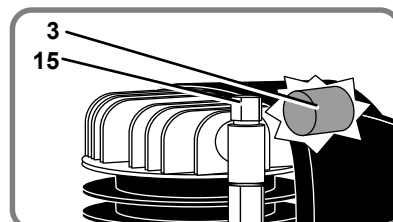

# PREPARATION

## INITIAL SET-UP:

1. Read safety warnings before setting-up air compressor.
2. Ensure the oil level is above the minimum notch and below the maximum notch on the dipstick. If low, add compressor pump oil.
3. Remove plug from cylinder head port and replace w/ air filter.

## LOCATION:

### CAUTION

**In order to avoid damaging the air compressor, do not incline the air compressor transversely or longitudinally more than 10°.**

1. Place air compressor at least 12 inches away from obstacles that may prevent proper ventilation. Do not place air compressor in an area:
  - where there is evidence of oil or gas leaks.
  - where flammable gas vapors or materials may be present.

### WARNING



**Serious injury or death may occur if electrical sparks from motor and pressure switch come in contact with flammable vapors, combustible dust, gases or other combustible materials. When using the air compressor for spray painting, place the air compressor as far away from the work area as possible, using extra air hoses instead of extension cords.**

- where air temperatures fall below 32°F or exceed 104°F.
- where extremely dirty air or water could be drawn into the air compressor.

## ELECTRICAL:

### DANGER



**Improper connection of the equipment-grounding conductor can result in a risk of shock or electrocution. Check with a qualified electrician or service personnel if you are in doubt as to whether the outlet is properly grounded. Do not use any type of adapter with this product. If repair or replacement of the cord or plug is necessary, do not connect the grounding wire to either flat blade terminal. The wire with insulation having an outer surface that is green with or without yellow stripes is the grounding wire.**

### WARNING



**This product must be grounded. If there should be a malfunction or breakdown, grounding provides a path of least resistance for electric current to reduce the risk of electric shock. This product is equipped with a cord having an equipment-grounding conductor and a grounding type plug. The plug must be plugged into an appropriate outlet that is properly installed and grounded in accordance with all local codes and ordinances.**

1. Senco® DOES NOT RECOMMEND THE USE OF EXTENSION CORDS as this can create power loss and overheating of the motor. Use of an additional air hose is recommended rather than an extension cord. If use of an extension cord is unavoidable, it should be plugged into a GFCI found in circuit boxes or protected receptacles. When using an extension cord, observe the following:

Cable Length	Wire Gauge
Up to 25 feet	12 AWG
Up to 100 feet	10 AWG
Up to 150 feet	8 AWG
Up to 250 feet	6 AWG

Use only 3-blade extension cords that have 3-blade grounding-type plugs and 3-slot cord connectors that will accept the plug from the product. Use only extension cords having an electrical rating not less than the rating of the product. Do not use damaged extension cords. Examine extension cord before using and replace if damaged. Do not abuse extension cord and do not yank on any cord to disconnect. Keep cord away from heat and sharp edges. Always shut off the air compressor switch before removing the plug from the receptacle.

## OPERATION

### PRE-START CHECKLIST:

1. Check oil level. Add if necessary.
2. Remove any moisture in the air compressor air tank. Remove excessive pressure with an air tool or by pulling the safety relief valve ring, then open the air tank drain valve in the bottom of the air tank. Close tightly when drained.



**WARNING: Risk of bodily injury. NEVER attempt to open the drain valve when more than 10 PSI of air pressure is in the air tank!**

3. Make sure the air compressor Motor Switch is in the "OFF" position.
4. Make sure all safety valves are working correctly.
5. Make sure all guards and covers are in place and securely mounted.
6. Make sure that air filter is placed in proper opening. Remove plug before threading housing into compressor.

### START-UP:

1. Ensure the lever on the pressure switch box is in the "OFF" position.
2. Plug the power cord into a grounded outlet.
3. Move the lever on the pressure switch box to the "ON" position.
4. **START/STOP:** Turn to the ON position. This will allow the air compressor to "START" building up pressure in the air tanks and "STOP" when correct pressure is achieved. When pressure drops with usage, the air compressor will automatically "START" building up pressure again.
5. Set pressure by adjusting the pressure regulator knob counterclockwise for less pressure and clockwise for more pressure.
6. If you notice any unusual noise or vibration, stop the air compressor and refer to "Troubleshooting".



### SHUTDOWN:

1. To stop the air compressor, move the lever on the pressure switch box to the "OFF" position. NEVER stop the air compressor by unplugging it from the power source. This could result in risk of electrocution.
2. Drain air from the air tanks by releasing air with an attached air tool or by pulling on the safety relief valve rings.
3. Once pressure in the air tanks register under 10 psig, open the drain valve under each air tank to drain any moisture.
4. Allow the air compressor to cool down.
5. Wipe air compressor clean and store in a safe, non-freezing area.

## MAINTENANCE

Read the instruction manual before performing maintenance. The following procedures must be performed when stopping the air compressor for maintenance or service.

1. Turn off air compressor.

**WARNING: Never assume the air compressor is safe to work on just because it is not operating. It could restart anytime!**

2. Disconnect cord from main power supply.
3. Open all drains.
4. Wait for the air compressor to cool before starting service.

### MAINTENANCE CHART

PROCEDURE	DAILY	WEEKLY	MONTHLY	200 HOURS
Check pump oil level	X			
Oil leak inspection	X			
Drain condensation in air tank(s)	X			
Check for unusual noise/vibration	X			
Check for air leaks	X			
Inspect air filter		X		
Clean exterior of compressor		X		
Check safety relief valve			X	
Change pump oil*				X
Replace air filter				X

\*The pump oil must be changed after the first 50 hours of operation and every 200 hours or 3 months, whichever comes first. Recommended non-detergent straight weights.

## TROUBLESHOOTING

### Symptom 1. Motor will not run or restart.

Power cord not plugged in.	Plug cord into grounded outlet.
Motor/Pressure switch in "OFF" position.	Move switch to "AUTO" position.
Motor overload switch has tripped.	Turn air compressor off, wait until motor is cool, then press motor overload button.
Fuse blown or circuit breaker has tripped.	Replace fuse or reset circuit breaker. Check for proper fuse amperage. Check for low voltage conditions. Disconnect any other electrical appliances from circuit or operate air compressor on its own branch circuit.
Wrong gauge wire or length of extension cord.	Check chart on page #10 for proper gauge wire and cord length.
Air tank pressure exceeds motor/pressure switch "cut-in" pressure.	Motor will start automatically when air tank pressure drops below "cut-in" pressure of motor/pressure switch.
Pressure release valve on motor/pressure switch has not unloaded pump head pressure.	Bleed the line by moving the switch to the "Off" position.
Defective motor, motor capacitor, motor/pressure switch, or check valve.	Contact Senco Customer Service.

### Symptom 2. Noisy operation.

Lack of oil in the pump.	Add correct amount of oil. Check for bearing damage.
Carbon deposits on pistons or valves.	Remove cylinder head and inspect. Clean or replace.
Bearing, piston or connecting rod failure.	STOP THE COMPRESSOR! Contact Senco Customer Service.

### Symptom 3. When in the ON position, motor runs continuously.

#### PROBABLE CAUSE

Motor/Pressure switch does not shut off motor when air compressor reaches "cut-out" pressure and safety relief valve activates.

Air compressor is incorrectly sized.

#### REMEDY

Move the motor/pressure switch to the "Off" position. If the motor doesn't shut off, unplug the air compressor. If the electrical contacts are welded together, replace the pressure switch.

Limit the air pressure to the capacity of the air compressor. Either use a smaller tool or a larger air compressor.

# TROUBLESHOOTING

## Symptom 4. Air continues to leak at motor/pressure switch release valve after motor stops.

### PROBABLE CAUSE

Defective valve, the check valve is stuck open.

### REMEDY

Remove, clean or replace.

## Symptom 5. Air continues to leak at motor/pressure switch release valve while motor is running.

### PROBABLE CAUSE

Defective motor/pressure switch.

### REMEDY

Replace.

## Symptom 5A. Air continues to leak at cold start valve longer than 20 seconds.

### PROBABLE CAUSE

Possible defective valve.

### REMEDY

Contact SENCO Customer Service 888-222-8144.

Additional air leaks.

Check drains, quick disconnect or reg.

## Symptom 6. Air leaks from safety relief valve.

### PROBABLE CAUSE

Possible defective safety relief valve.

### REMEDY

Operate safety relief valve manually by pulling on ring. If it still leaks, it should be replaced.

Excessive air tank pressure.

Defective motor/pressure switch. Replace.

## Symptom 7. Air leaks at pump.

### PROBABLE CAUSE

Defective gaskets.

### REMEDY

Replace and torque head bolts to 20 ft./lbs.

## Symptom 8. Air leaks at fittings.

### PROBABLE CAUSE

Fittings are not tight enough.

### REMEDY

Tighten fittings where air can be heard escaping. Check fittings with soapy water solution. **Do not overtighten.**

## Symptom 9. Air leak in air tank.

### PROBABLE CAUSE

Defective or rusted air tank.

### REMEDY

Air tank must be replaced. **Do not attempt to repair air tank!**

## Symptom 10. Air blowing from inlet filter.

### PROBABLE CAUSE

Damaged inlet (reed) valve.

### REMEDY

Contact SENCO Customer Service 888-222-8144.

# TROUBLESHOOTING

## Symptom 11. Insufficient pressure at air tool or accessory.

### PROBABLE CAUSE

Pressure regulator knob not turned to high enough pressure or defective pressure regulator.

Restricted air intake filter.

Air leaks.

Hose or hose connections are too small or long.

Air compressor is not large enough for air requirement.

### REMEDY

Adjust pressure regulator knob to proper setting or replace.

Clean or replace.

Check for leaks and repair.

Replace with larger hose or connectors.

Check the accessory air requirement. If it is higher than the CFM or pressure supply of the air compressor, you need a larger air compressor.

## Symptom 12. Air compressor not making enough air.

### PROBABLE CAUSE

Restricted air intake filter.

Defective (reed) valve.

Restriction in pilot valve.

### REMEDY

Clean or replace.

Drain air tank and measure pump up time. Compare to specifications. If lower, remove pump head and inspect valve plate, clean or replace.

Clean or replace.

## Symptom 13. Excessive oil consumption in pump.

### PROBABLE CAUSE

Restricted air intake filter.

Air compressor on unlevel surface.

Crankcase overfilled with oil.

Plugged oil dipstick vent.

Oil leaks.

Worn piston rings or scored cylinder.

### REMEDY

Clean or replace.

Do not incline the air compressor more than 10° in any direction while running.

Drain oil. Refill to proper level with oil.

Clean.

Repair.

Contact Senco Customer Service.

## Symptom 14. Oil has milky appearance.

### PROBABLE CAUSE

Water in oil due to condensation.

### REMEDY

Change oil and move air compressor to a less humid environment.

## Symptom 15. Moisture in discharge air.

### PROBABLE CAUSE

Condensation in air tank caused by high level of atmospheric humidity or air compressor is not run long enough.

### REMEDY

Drain air tank after every use. Drain air tank more often in humid weather and use an air line filter.

## SPECIFICATIONS

Model #	PC1130
Motor	
Horsepower	1.0 running, 1.5 peak
Voltage	115
Amperage	13
Hz.	60
Phase	Single
RPM	3400
Compressor Pump	
Number of Cylinders	1
Compression Stage	1
Lubrication	Splash
Oil Type	SESCO PC 0344
Oil Capacity	7 oz.
Crankcase	Aluminum
Bearings	Ball
Cylinder	Cast iron
Valves	Reed-Single
Head	Aluminum
Filter	Foam Insert
Motor/Pressure Switch Setting	
Cut-out	125 PSI
Cut-in	95 PSI
Controls	Start/stop
Air tank	
Capacity	2.5 gallon
Performance	
CFM Air Displacement	7.7
CFM @ 90 PSI	3.5
CFM @ 125 PSI	3.2
Maximum Pressure	125 PSI
Pump-up Time: 0-125 PSI	38 seconds
Recovery Time: 90-125 PSI	10 seconds
Weight	
Net	39 lbs
Shipping	42 lbs.
Dimensions	
Basic LxWxH	21"x8"x18.5"
Running Duty Type	S1 @ 100 psig
Noise	79 dBA



# SENCO COMPRESSOR AND PARTS WARRANTY

This compressor has been designed and constructed using the highest standards of material and workmanship.

## COMPRESSOR WARRANTY:

The length of this guarantee is **one year** from date of purchase by the **original retail purchaser**. During this period, Senco Products, Inc., will repair or replace at Senco's option, any original part or parts for the original retail purchaser. This will be done free of charge, provided the parts are determined defective in materials or workmanship upon examination by a Senco Authorized Warranty Service Center, with the exceptions and exclusions described below. Any replacement part provided will carry a warranty for the balance of the period of warranty applicable to the part it replaces. When repair or replacement of parts or compressor is necessary, the original retail purchaser returns the complete compressor or part, with transportation prepaid, to the nearest Senco Authorized Warranty Service Center, with purchase receipt or other positive proof that the part or compressor is within the warranty period.

Senco warrants all parts (except those listed below) of your Senco air compressor to be free from defects in materials and workmanship during the following periods:

1. For 1 year from date of original purchase:  
Compressor Pump      Pilot Valve  
Tank Assembly        Plumbing  
Flywheel                Throttle Control  
Power Cord
2. For 90 days from date of original purchase:  
Pressure Gauge        Pressure Relief  
Valve Draincocks

Defective parts not subject to normal wear and tear will be repaired or replaced, at our (Senco's) option, during warranty period. In any event, reimbursement is limited to the purchase price paid.

## EXCLUSIONS:

1. Engine/Motor is covered under separate warranty by its respective manufacturer and is subject to the terms set forth therein.
2. Normal wear parts not covered under warranty:  
Isolators                Drive Belt  
Air Filter
3. This warranty does not cover parts damaged due to normal wear, misapplication, misuse, accidents, operation at other than recommended speeds or voltage (electric units only), improper storage, or damages resulting during shipping.
4. Deviation from operating instructions, specifications, and maintenance schedules.
5. Labor charges, loss or damage resulting from improper operation, maintenance or repairs made by person(s) other than a Senco Authorized Warranty Service Center.
6. The use of other than genuine Senco Repair Parts will void warranty.

This warranty is contingent upon proper use of the compressor by purchaser and does not cover:

- (A) Abnormal conditions, accident, neglect, misuse or improper storage of the unit.
- (B) Deviation from operating or maintenance instructions.
- (C) Modifications not authorized by Senco.
- (D) Repairs or maintenance (other than routine air tank draining and oil changes required by your operating and maintenance manual) made by persons other than Senco or its authorized agents.
- (E) Freight damage.

THIS WARRANTY IS THE ONLY WARRANTY ON THIS COMPRESSOR, AND ALL OTHER WARRANTIES, WHETHER ORAL, WRITTEN, EXPRESS, OR IMPLIED, INCLUDING, BUT NOT LIMITED TO, THE IMPLIED WARRANTY OF MERCHANTABILITY OR FITNESS FOR A PARTICULAR PURPOSE, ARE EXCLUDED. BUYER'S OR USER'S REMEDIES ARE SOLELY AND EXCLUSIVELY AS STATED ABOVE. SENCO PRODUCTS, INC. SHALL IN NO EVENT BE LIABLE FOR INCIDENTAL, CONSEQUENTIAL, INDIRECT, OR SPECIAL DAMAGES. IN NO EVENT, WHETHER AS A RESULT OF A BREACH OF CONTRACT, WARRANTY, TORT (INCLUDING NEGLIGENCE) OR OTHERWISE, SHALL SENCO'S LIABILITY EXCEED THE PRICE OF THE COMPRESSOR WHICH HAS GIVEN RISE TO THE CLAIM OR LIABILITY. ANY LIABILITY CONNECTED WITH THE USE OF THIS COMPRESSOR SHALL TERMINATE UPON THE EXPIRATION OF THE WARRANTY PERIOD SPECIFIED ABOVE.

### Replacement of Compressor Due to Natural Disaster

Senco will also replace any compressor destroyed by an Act of God such as flood, earthquake, hurricane or other disaster resulting only from the forces of nature. Such a claim will be honored provided that such original retail purchaser had previously submitted a completed warranty registration card, and then submits proof of ownership and an acceptable statement describing such Act of God documented by an insurance carrier, police department, or other official governmental source. To obtain instructions for filing a claim call 1-800-543-4596.

**SENCO PRODUCTS, INC.**  
**CINCINNATI, OHIO 45244-1611 USA**